

Serie 9000

 9200 Pag. 17.8	 9220 Pag. 17.8	 9230 Pag. 17.8	 9260 Pag. 17.8	 9280 Pag. 17.9	 9460 Pag. 17.9	 9480 Pag. 17.9	 9500 Pag. 17.9	 9550 Pag. 17.10	
 9680 Pag. 17.10	 9740 Pag. 17.10	 10770 Pag. 17.10							

Serie 10000

 10200 Pag. 17.14	 10220 Pag. 17.14	 10230 Pag. 17.14	 10240 Pag. 17.14	 10260 Pag. 17.15	 10280 Pag. 17.15	 10290 Pag. 17.15	 10460 Pag. 17.15	 10465 Pag. 17.16
 10480 Pag. 17.16	 10485 Pag. 17.16	 10500 Pag. 17.17	 10510 Pag. 17.17	 13530 Pag. 17.17	 13540 Pag. 17.18	 10550 Pag. 17.18	 10680 Pag. 17.18	 10740 Pag. 17.18
 10760 Pag. 17.19	 10770 Pag. 17.19	 13780 Pag. 17.19	 1612 Pag. 17.19	 1613 Pag. 17.19				

Serie 13000

 13200 Pag. 17.24	 13220 Pag. 17.24	 13230 Pag. 17.24	 13240 Pag. 17.24	 13260 Pag. 17.25	 13280 Pag. 17.25	 13290 Pag. 17.25	 13300 Pag. 17.26	 13460 Pag. 17.26
 13465 Pag. 17.26	 13480 Pag. 17.26	New  13483 Pag. 17.27	 13485 Pag. 17.27	 13500 Pag. 17.28	 13510 Pag. 17.28	 13530 Pag. 17.28	 13540 Pag. 17.29	 13550 Pag. 17.29
 13550BI Pag. 17.29	 13570BI Pag. 17.30	 13958BI Pag. 17.30	 13600 Pag. 17.30	 13680 Pag. 17.30	 13740 Pag. 17.31	 13780 Pag. 17.31	 10770 Pag. 17.31	 1612 Pag. 17.31
 1613 Pag. 17.31	New  13800 Pag. 17.32	New  13805 Pag. 17.33	 13810 Pag. 17.33	New  13820 Pag. 17.34	New  13825 Pag. 17.34	 TBPL Pag. 17.35		

Aignep si riserva il diritto di variare modelli e ingombri senza preavviso - Aignep reserves the right to vary models and dimensions without notice - Aignep behält sich das Recht vor, Daten ohne Ankündigung zu ändern
 Aignep se réserve le droit de modifier les données sans préavis - Aignep se reserva el derecho de modificar modelos y dimensiones sin previo aviso - Aignep reserva-se o direito de alterar os modelos e dimensões sem prévio aviso

RACCORDI A COMPRESSIONE, RACCORDI A BICONO E RACCORDI UNIVERSALI

COMPRESSION FITTINGS, DOUBLE CONE FITTINGS AND UNIVERSAL FITTINGS

KLEMMRING VERSCHRAUBUNGEN, DOPPELKEGEL VERSCHRAUBUNGEN, UNIVERSAL VERSCHRAUBUNGEN

RACCORDS À COMPRESSION, RACCORDS À BICONE, RACCORDS UNIVERSELS LAITON

RACORDAJE A COMPRESIÓN, RACORDAJE UNIVERSAL A BICONO, RACORDAJE UNIVERSAL

CONEXÕES DE COMPRESSÃO, CONEXÕES UNIVERSAIS DE CONE DUPLO, CONEXÕES UNIVERSAIS



Serie Compression Fittings

Le 3 gamme di raccordi a compressione in ottone Aignep si differenziano principalmente per le normative di riferimento, le applicazioni e le caratteristiche tecniche delle ogive.

Con queste tre tipologie Aignep rappresenta la scelta più ampia del mercato e riesce a risolvere problemi applicativi ben noti. Le possibilità di utilizzo e di connessione sono molteplici, si possono connettere in assoluta sicurezza tubi rigidi metallici (ottone, rame, alluminio) e tubi in materiali termo plastici come poliuretano, poliammide e teflon. Disponibili Ogive in teflon.

Serie 9.000	DIN 3861
Serie 10.000	DIN 3862 (Bicono)
Serie 13.000	UNI EN 1254 2:2000 (universale)

Principali vantaggi

- 3 tecnologie di connessione
- Compatibilità numerosi fluidi industriali
- Tenuta garantita su differenti tipologie di tubi
- Senza elementi di tenuta (elastomeri)
- Dal ø 4 al ø 22 mm
- Robustezza meccanica
- Versioni con nichelatura
- Silicon Free

Applicazioni

- Automazione Pneumatica pesante
- Automotive
- Raffreddamento industriale
- Gas inerti, vapore, lubrificazione
- Vuoto

Aignep offers 3 lines of compression fittings in brass according to different manufacturing directives. This wide selection helps to satisfy the most demanding needs of the market.

Especially designed for connection with metallic tubes (brass, copper, aluminium) to secure connection in low-medium pressure. Connection with PU, PA and PTFE tubes with a smart internal bush.

9.000 Serie	DIN 3861
10.000 Serie	DIN 3862 (Dual cone)
13.000 Serie	UNI EN 1254 2:2000 (Universal)

Main advantages

- 3 Connection Technologies
- All industrial fluids compatibility
- Secured connection with different tubes
- Metallic sealing
- From ø 4 to 22 mm
- Mechanical Resistance
- Nickel-plated version
- Silicon Free

Applications

- Heavy Pneumatic Automation
- Automotive
- Industrial cooling
- Inert Gases, Steam
- Vacuum

Aignep bietet drei Serien von Klemmringverschraubungen aus Messing an, welche sich vor allem durch verschiedene Herstellungsrichtlinien unterscheiden. Dank dieser großen Auswahl können auch die anspruchsvollsten Nachfragen erfüllt werden.

Speziell entwickelt für die sichere Verbindung von Metall-Rohren (Messing, Kupfer, Aluminium) bei geringem bis mittlerem Druck. Verbindung mit PU, PA und PTFE-Schläuchen mit einer Stützhülse.

9.000er Serie	DIN 3861
10.000er Serie	DIN 3862 (Doppelkegel)
13.000er Serie	UNI EN 1254 2:2000 (Universal)

Hauptvorteile

- 3 Verbindungs-Technologien
- Kompatibel mit allen Medien
- Sichere Verbindung mit allen Rohren
- Metall-Dichtungen
- Von ø 4 bis 22 mm
- Mechanische Festigkeit
- Vernickelte Version
- Silikonfrei

Anwendungen

- Schwere pneumatische Automation
- Automotive
- Industrie-Kühlung
- Inertgase, Dampf

Aignep propose 3 gammes de raccords à compression en laiton selon différentes normes.

Cette large sélection permet de répondre à tous les besoins dans de nombreuses applications industrielles.

Spécialement conçus pour le raccordement avec des tubes métalliques rigides (Laiton, cuivre, aluminium) ils garantissent une parfaite sécurité dans la connexion en basse et moyenne pression.

Raccordement avec du tube PU, PA et PTFE possibles en utilisant une fourrure intérieure.

Série 9000	selon DIN 3861
Série 10000	selon DIN 3862 (Bi cone)
Série 13000	selon UNI EN 1254 2: 2000 (Universelle)

Principaux avantages

- 3 Technologies de raccordement
- Compatibilité avec tous les fluides industriels
- Connexion sécurisée avec différents tubes
- Étanchéité métal/métal
- De ø 4 à 22 mm
- Excellente résistance mécanique
- Versions nickelées ou brute
- Sans silicone

Applications

- Automatismes pneumatiques – milieux sévères
- Process Automobile
- Refroidissement industriel
- Gaz neutre, vapeur
- Vide

Las 3 gamas de racores a compresión en latón Aignep se diferencian principalmente por las normativas de referencia, las aplicaciones y las características técnicas de los anillos.

Con estas tres tipologías Aignep representa la elección mas amplia del mercado y resuelve problemas aplicativos de forma notable. Las posibilidades de utilización y de conexión son múltiples, pueden conectarse con absoluta seguridad tubos rígidos metálico (latón, cobre, aluminio) y tubos en material plástico como poliuretano, poliamida y teflón. Disponibles anillos en teflón.

Serie 9.000	DIN 3861
Serie 10.000	DIN 3862 (bicono)
Serie 13.000	UNI EN 1254 2:2000 (Universal)

Principales ventajas

- 3 tecnologías de conexión
- Compatibilidad con numerosos fluidos industriales
- Estanqueidad garantizada con diferentes tipologías de tubo
- Sin elementos de estanqueidad (Elastómeros)
- Del diam. 4 al diam 22 mm
- Robustez mecánica
- Versión con niquelatura
- Libres de silicona

Aplicaciones

- Automatización neumática pesada
- Automoción
- Refrigeración industrial
- Gases inertes, vapor, lubricación
- Vacío

A Aignep oferece 3 linhas de conexões de compressão em latão de acordo com diferentes diretivas de fabricação.

Esta ampla gama de itens auxilia a atender as mais complexas necessidades do mercado.

Especialmente desenvolvido para conectar tubos metálicos (latão, cobre, alumínio) e assegurar conexões em pressões médias e baixas.

Conexão com tubos em PU, PA e PTFE através de uma bucha interna.

9.000 Série	DIN 3861
10.000 Série	DIN 3862 (Dual cone)
13.000 Série	UNI EN 1254 2:2000 (Universal)

Principais vantagens

- 3 Tecnologia de Conexão
- Compatibilidade com todos os fluidos industriais
- Conexão segura com diferentes tubos
- Vedação Metálica
- Para tubos de ø 4 a 22 mm
- Resistência Mecânica
- Versão Niquelada
- Livre de Silicone

Aplicações

- Automação Pneumática Pesada
- Automotiva
- Refrigeração Industrial
- Gases Inertes, Vapor
- Vácuo



Montaggio

IT

Per garantire le migliori prestazioni dei nostri raccordi, riportiamo una sequenza di operazioni da eseguire durante il montaggio, che contribuiranno ad eliminare sprechi di tempo e cattive applicazioni del prodotto.

Assembling

GB

To ensure the best function of our fittings, please follow the under mentioned instructions, in order to avoid waste of time and bad applications of the product.

Montageanleitung

DE

Um eine optimale Leistung unserer Armaturen zu gewährleisten haben wir in den folgenden Schritten die Montage der Verbindung dokumentiert. Damit sollte keine falsche Montage durchgeführt und keine verschwendete Zeit benötigt werden.

Assemblage

FR

Pour assurer le bon fonctionnement des raccords, veuillez suivre les instructions de montage ci-dessous afin d'éviter le gaspillage de temps et une mauvaise utilisation des produits.

Montaje

ES

Para garantizar las mejores prestaciones de nuestros racores, indicamos una secuencia de operaciones para seguir durante el montaje, que contribuirán a eliminar pérdidas de tiempo, e incorrectas aplicaciones del producto.

Montagem

PT

Para garantir o melhor funcionamento das nossas conexões, mostramos a seguir uma sequência de operações a serem executadas durante a montagem, de forma a evitar desperdícios de tempo e má aplicação do produto.

1

Tagliare il tubo a 90° togliendo le bave interne ed esterne.

Cut the tube at 90° and remove internal and external burrs.

Schneiden Sie das Rohr 90° und entgraten Innen- und Aussen- kanten.

Couper le tube à 90° et l'ébavurer.

Cortar el tubo a 90° eliminando rebabas internas y externas.

Cortar o tubo a 90° e remover a as rebarbas internas e externas.

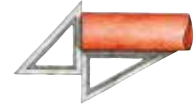

2

Oliare le filettature del dado e del corpo del raccordo, compresa l'ogiva. Quindi infilare sul tubo dado e ogiva, facendo attenzione che quest'ultima abbia la parte tagliente verso il raccordo.

Lightly oil the tube nut, olive and fitting thread. Slide the nut and olive onto the tube ensuring that the sharp side of the olive is facing the fitting.

Oelen Sie das Gewinde der Überwurfmutter und des Körpers, einschliesslich der Nute für den Klemmring. Schieben Sie die Überwurfmutter und den Klemmring, mit der scharfen Kante des Klemmrings gegen den Körper, über das Rohr.

Huiler le filet de l'écrou et celui du corps du raccord. Insérer l'écrou et la bague (côté affûté contre le corps du raccord) sur le tube.

Poner aceite en la rosca de la tuerca y del cuerpo del racor incluyendo el bicono. Seguidamente enfilar en el tubo la tuerca y el bicono, asegurando que este último tenga la parte cortante hacia el racor.

Lubrificar levemente a rosca da porca, o corpo da conexão e a bucha. Deslizar a porca e a bucha pelo tubo, garantindo que o lado mais afiado da bucha esteja voltado para a conexão.



3

Avvitare manualmente il dado fino ad ottenere una certa resistenza dell'ogiva.

Screw the nut onto the fitting by hand until hand-tight.

Schrauben Sie die Überwurfmutter von Hand soweit an, bis Sie einen Widerstand bemerken.

Visser manuellement l'écrou jusqu'à obtenir une certaine résistance.

Apertar manualmente la tuerca hasta obtener cierta resistencia del bicono.

Apertar manualmente a porca sentir resistência da bucha.



4

Verificare la completa adesione del tubo al corpo, forzando il medesimo verso l'interno del raccordo e quindi, con la chiave, bloccare il tubo.

Ensure the tube is pushed fully home into the fitting before tightening the nut with the correct spanner.

Bevor Sie die Überwurfmutter mit dem Schlüssel anziehen stellen Sie sicher, dass das Rohr ganz an den Anschlag in die Verschraubung geschoben ist.

Avant de serrer l'écrou avec la clé, vérifiez que le tube est en butée dans le corps du raccord.

Verificar la completa adhesión del tubo al cuerpo, forzándolo hacia el interno del racor y seguidamente con la llave, bloquear el tubo.

Garantir que o tubo esteja bem encaixado dentro da conexão antes de apertar a porca com a chave adequada. Se necessário, antes de apertar, empurre o tubo um pouco mais.



5

Stringere il dado (come indicato da tabella) ponendo, se necessario, dei punti di riferimento.

Tighten the nut with the spanner (see the chart), marking reference points, if necessary.

Ziehen Sie die Mutter mit dem Schlüssel (siehe tabelle) Umgang an, wenn nötig machen Sie Bezugspunkte.

Visser l'écrou en le tournant avec une clé (voir tableau). Si nécessaire, faire un repère de serrage.

Apertar la tuerca (ver tabla) indicando si es necesario un punto de referencia.

Aperte a porca (ver tabela). Se necessário use marcar de referência.

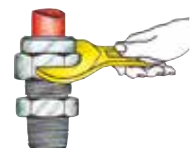

6

A garanzia che l'ogiva abbia inciso il tubo svitare il dado e controllare l'uniformità del solco.

To ensure that the olive has gripped the tube correctly. Unscrew the nut and make sure that the groove made by the olive is even.

Um sicherzustellen, dass der Klemmring das Rohr richtig gegriffen hat, lösen Sie die Mutter vom Körper.

Comme contrôle, dévissez l'écrou du corps et vérifiez que la bague est bien sertie sur le tube.

Para garantizar que el bicono haya incidido el tubo, aflojar la tuerca y controlar la uniformidad del apriete.

Para garantir que a bucha foi adequadamente prensada no tubo, solte a conexão e analise o rebaixo de cravamento da bucha.



7

Riserrare il dado per circa 1/4 di giro. Altra avvertenza per un buon montaggio: nel caso di tubi curvi, in prossimità del raccordo, il tubo stesso dovrà avere una distanza rettilinea almeno pari al doppio dell'altezza del dado.

Tighten the nut again with an extra quarter turn. Additional information to ensure correct assembly. Where fitting to curved tubes ensure that the section entering the fitting is straight for a minimum length of twice the nut height.

Ziehen Sie die Mutter wieder mit 1/4 Drehung an. Zusätzliche Information für eine korrekte Montage: Beim Einsatz von gebogenen Rohren in der Nähe der Verschraubung sollte das Rohr mindestens die doppelte Länge der Mutter gerade sein.

Revisser l'écrou en le tournant avec une clé sur 1 tour 1/4. Informations complémentaires pour un montage correct: Lors de l'utilisation d'un tube cintré, une longueur de tube droite égale à 2x la longueur de l'écrou et à respecter avant la connexion.

Apertar la tuerca cerca de 1/4 de giro. Otra advertencia para un buen montaje: En el caso de tubos curvados, en proximidad del racor, el tubo deberá tener una distancia rectilínea por lo menos del doble de la altura de la tuerca.

Aperte a porca novamente com 1/4 de giro adicional. Outra informação para uma boa montagem: no caso de tubos curvados, garanta que a parte do tubo que foi encaixada na conexão seja reta e tenha comprimento igual ou maior a duas vezes a altura da porca.

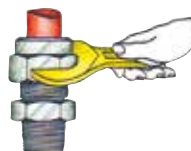

RACCORDI A COMPRESSIONE

COMPRESSION FITTINGS

KLEMMRING VERSCHRAUBUNGEN

RACCORDS À BAGUES BICÔNE

RACORDAJE A COMPRESIÓN

CONEXÕES DE COMPRESSÃO





CARATTERISTICHE TECNICHE
 TECHNICAL CHARACTERISTICS
 TECHNISCHE ANGABEN
 CARACTÉRISTIQUES TECHNIQUES
 CARACTERÍSTICAS TÉCNICAS
 CARACTERÍSTICAS TÉCNICAS



Norma di Riferimento
 Reference standard
 Entspricht der Norm
 Norme de référence
 Normativa de referencia
 Norma de referência

1907/2006
REACH ✓

2011/65/CE
RoHS ✓

PED
 2014/68/UE

**SILICON
 FREE**

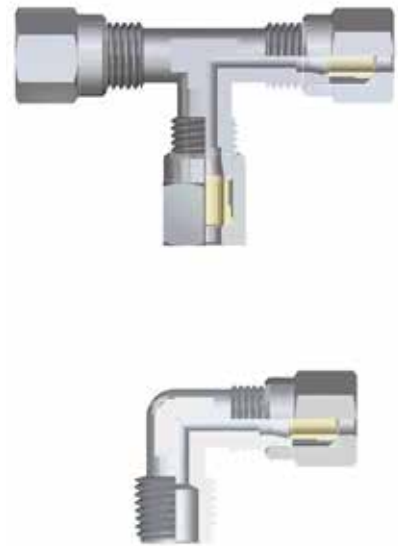
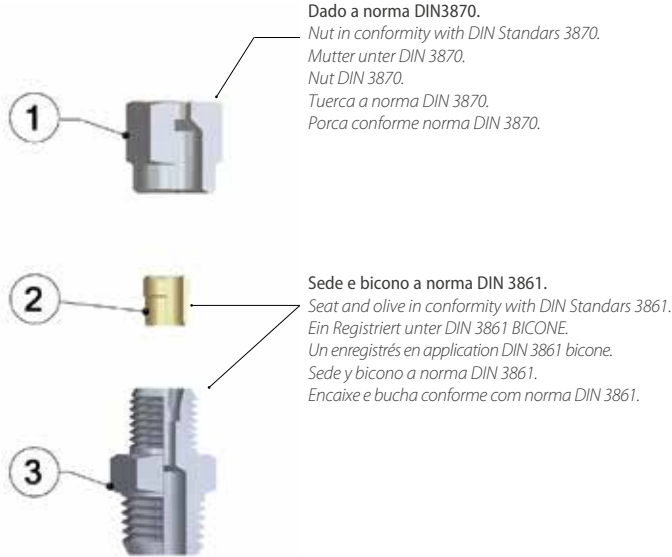

Materiali e Componenti	IT	Component Parts and Materials	GB	Komponenten und Materialien	DE
1 Dado in Ottone nichelato 2 Ogiva in Ottone Ricotto 3 Corpo in Ottone nichelato		1 Nickel-plated Brass Nut 2 Annealed Brass Olive 3 Nickel-plated Brass Body		1 Überwurfmutter Messing vernickelt 2 Klemmring Messing geglüht 3 Körper Messing vernickelt	
Matériaux et Composants	FR	Materiales y Componentes	ES	Materiais e Componentes	PT
1 Ecrin: laiton nickelé 2 Bague bicône: laiton 3 Corps: laiton nickelé		1 Tuerca en Latón niquelado 2 Bicono en Latón Recocido 3 Cuerpo en Latón niquelado		1 Porca em Latão niquelado 2 Bucha em Latão Temperado 3 Corpo em Latão niquelado	



Tubi di Collegamento	IT	Connection Tubes	GB	Geeignete Rohre	DE
Tubi in rame, ferro, acciaio, alluminio, ottone, PA.		Tubes made in copper, steel, iron, aluminium, brass, PA.		Rohre in Kupfer, Eisen, Stahl, Aluminium, Messing, PA.	
Tubes Conseillés	FR	Tubos de Conexión	ES	Tubos de Conexão	PT
Tubes en cuivre, acier, aluminium, laiton, PA.		Tubos en cobre, hierro, acero, aluminio, latón, PA.		Tubos de cobre, ferro, aço, alumínio, latão, PA.	



Filettatura	IT	Threads	GB	Gewindearten	DE
Gas conica conforme ISO 7.1, BS 21, DIN 2999. Gas cilindrica conforme ISO 228 Classe A. Metrica conforme ISO R/262.		Tapered gas in conformity with ISO7.1, BS 21, DIN 2999. Parallel gas in conformity with ISO 228 Class A. Metric in conformity with ISO R/262.		Konisches Gewinde nach Norm ISO 7.1, BS 21, DIN 2999. Zylindrisches Gewinde nach Norm ISO 228 Classe A. Metrisches Gewinde nach Norm ISO R/262.	
Filetages	FR	Roscas	ES	Roscas	PT
Filetage conique conforme: ISO7.1, BS 21, DIN 2999. Filetage cylindrique conforme: ISO 228 Classe A. Filetage métrique conforme: ISO R/262.		Gas cónica conforme ISO 7.1, BS 21, DIN 2999. Gas cilíndrica conforme ISO 228 Clase A. Métrica conforme ISO R/262.		Gas cônica conforme ISO 7.1, BS 21, DIN 2999. Gas paralela conforme ISO 228 Classe A. Métrica conforme ISO R/262.	



Temperature

Temperatures

Temperatur

Températures

Temperaturas

Temperaturas

- 60 °C

+ 300 °C



Fluidi compatibili

Acqua / Olio / Aria compressa

Fluidi in genere per l'impiantistica idraulica, oleodinamica, idropneumatica, ecc.

Fluids

Water / Oils / Compressed air

Fluids in general for the hydraulic, pneumatic and oildynamic plants etc.

Geeignete Medien

Wasser / Oel / Druckluft

Medien im Allgemeinen für hydraulische-, hydro-pneumatische- und pneumatische Anlagen, usw.

Fluides compatibles

Eau / Huile / Air comprimé

Fluides courants utilisés en hydraulique et pneumatique, etc.

Fluidos compatibles

Agua / Aceite / Aire comprimido

Fluidos en general para los campos hidráulicos, neumáticos y oleodinámicos, etc.

Fluidos compatíveis

Água / Óleo / Ar comprimido

Fluidos em geral para aplicações hidráulicas, oleodinâmicas, hidropneumáticas, etc.



Pressioni e Temperature

IT

Pressioni e temperature vengono determinate dal tipo di tubo impiegato, pertanto tali valori sono da definirsi in base alle caratteristiche del tubo stesso. Riportiamo di seguito i valori delle pressioni massime consigliate per l'utilizzo dei raccordi con tubi di rame dallo spessore di 1 mm a 20° C.

I valori delle pressioni consigliate, riportate in tabella, sono stati ottenuti dai valori di prova adottando un Coefficiente di Sicurezza 4.

Sono disponibili i certificati delle prove rilasciati dai vari laboratori che le hanno eseguite.

Pressures and Temperatures

GB

The working pressures and working temperatures depend on which type of tube is used, for this reason, the values must be determined in accordance with the tube's features.

Hereunder, we specify the values of the maximum pressure advised for the fittings at a temperature of 20° C connected with copper tube, which has a thickness of 1 mm.

The values of working pressures advised, specified in table have been obtained from the test values using a Safety Factor 4.

It is available the test report made by the external laboratory test.

Druckbereich und Temperatur

DE

Drücke und Temperaturen sind definiert durch die verwendete Ausführung der Leitung, d.h. die Werte der eingesetzten Rohre sind zu beachten.

Nachfolgend geben wir die Werte des maximalen Druckes für den Einsatz der Verschraubungen mit Kupferrohren an, deren Wandstärke min. 1mm beträgt und bei einer Temperatur von 20° C.

Es muss berücksichtigt werden, dass die angegebenen Druckwerte in der Tabelle mit einem Sicherheitsfaktors von 4 berechnet wurden.

Es stehen Prüfberichte zur Verfügung, die von verschiedenen, externen Labors gemacht wurden.

Pressions et Températures

FR

Les pressions et températures de service dépendent du type de tube utilisé. Pour cette raison, les valeurs doivent être déterminées en conformité avec les caractéristiques du tube. Ci-dessous, nous indiquons les valeurs de la pression maximale recommandée pour une connexion avec un tube en cuivre de 1 mm d'épaisseur à une température de 20° C.

Les pressions de service indiquées ont été calculées avec un coefficient de sécurité de 4.

Des rapports externes de tests sont disponibles sur demande pour attester ces valeurs.

Presiones y Temperaturas

ES

Presión y temperatura vienen determinadas según el tipo de tubo empleado, por lo tanto estos valores se definen en base a las características del mismo tubo. Representamos a continuación los valores de las presiones máximas aconsejadas para la utilización de los racores con tubo de cobre espesor 1 mm a 20° C.

Los valores de las presiones aconsejadas, representadas en la tabla, han sido obtenidas de valores de prueba adoptando un coeficiente de seguridad 4.

Están disponibles los certificados de las pruebas realizadas en distintos laboratorios especializados.

Pressões e Temperaturas

PT

Pressões e temperaturas dependem do tipo de tubo aplicado, portanto tais valores devem ser definidos com base nas características do tubo em questão.

A seguir apresentamos os valores das pressões máximas aconselhadas para a utilização das conexões com tubos de cobre de espessura de 1 mm a 20° C.

Os valores das pressões aconselhadas, reportados na tabela, foram obtidas dos valores de teste adotando-se um coeficiente de segurança 4.

Os certificados de teste executados por laboratórios externos estão disponíveis.

Misura Size Größe Dimensions Tamaño Tamanho	Pressione massima consigliata a 20 °C Maximum pressure advised at 20 °C Maximal Empfohlener Druck bei 20 °C Pression maximum conseillée à 20 °C Presión máxima aconsejada a 20 °C Pressão máxima aconselhada a 20 °C	
	kg/cm ²	bar
Ø		
4LL	130	128.6
6LL	180	178.1
8LL	150	148.4
10L	115	113.8
12L	75	72.4
14S	70	69.3
15S	70	69.3
16S	70	69.3
18L	65	64.3

9200

RACCORDO A T INTERMEDIO

TEE CONNECTOR

T-ANSCHLUSS

RACCORD TÉ

RACOR A T INTERMEDIO

CONEXÃO EM "T" TUBO-TUBO

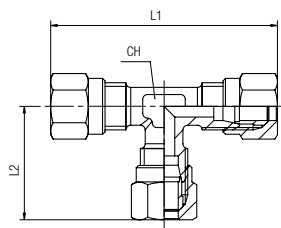

Code	Tube	L1	L2	CH	Pack.
09200 00 001	4	46	21	8	10
09200 00 002	6	48	22.5	9	10
09200 00 003	8	53	25	12	10
09200 00 004	10	65	31.5	13	10
09200 00 005	12	68	33	14	10
09200 00 006	14	76	42	17	10
09200 00 007	15	78	38	17	10
09200 00 008	16	86	42.5	19	10
09200 00 009	18	90	44	22	10

9220

RACCORDO A T MASCHIO CENTRALE

TEE MALE ADAPTOR - CENTRE LEG

T-EINSCHRAUBVERSCHRAUBUNG KONISCH

TÉ À PIQUAGE MÂLE CENTRAL, CONIQUE

RACOR A T MACHO CENTRAL

CONEXÃO EM "T" COM ROSCA MACHO CENTRAL

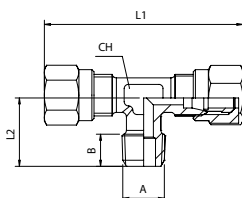

Code	Tube	A	B	L1	L2	CH	Pack.
09220 00 001	4	1/8	7.5	45	15	8	10
09220 00 002	6	1/8	7.5	45	16.5	9	10
09220 00 003	6	1/4	11	45	20.5	9	10
09220 00 004	8	1/8	7.5	52	17	12	10
09220 00 005	8	1/4	11	52	20.5	12	10
09220 00 006	8	3/8	11.5	50	24	13	10
09220 00 007	10	1/4	11	64	23.5	13	10
09220 00 008	10	3/8	11.5	64	24	13	10
09220 00 009	12	3/8	11.5	68	25	14	10
09220 00 010	12	1/2	14	68	26.5	14	10
09220 00 011	14	1/2	14	84	30	17	10
09220 00 012	15	1/2	14	76	28	17	10
09220 00 013	16	1/2	14	85	31.5	19	10
09220 00 014	18	1/2	14	88	34	22	10

9230

RACCORDO A T MASCHIO LATERALE

TEE MALE ADAPTOR OFF SET LEG

L-EINSCHRAUBVERSCHRAUBUNG KONISCH

TÉ À PIQUAGE LATÉRAL, CONIQUE

RACOR A T MACHO LATERAL

CONEXÃO EM "T" COM ROSCA MACHO LATERAL

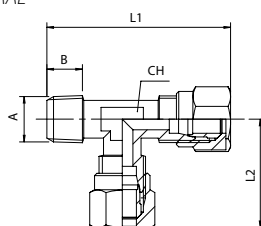

Code	Tube	A	B	L1	L2	CH	Pack.
09230 00 001	4	1/8	7.5	37.5	21	8	10
09230 00 002	6	1/8	7.5	39.5	22.5	9	10
09230 00 003	6	1/4	11	43	23	9	10
09230 00 004	8	1/8	7.5	43.5	25	12	10
09230 00 005	8	1/4	11	47	25	12	10
09230 00 006	8	3/8	11.5	50	25	13	10
09230 00 007	10	1/4	11	55.5	31	13	10
09230 00 008	10	3/8	11.5	56.5	31.5	13	10
09230 00 009	12	3/8	11.5	59	33	14	10
09230 00 010	12	1/2	11.5	59.5	25	15	10
09230 00 011	14	1/2	14	68	42	17	10
09230 00 012	15	1/2	14	68	38	17	10
09230 00 013	16	1/2	14	74.5	42.5	19	10
09230 00 014	18	1/2	14	79	44	22	10

9260

RACCORDO A L INTERMEDIO

ELBOW CONNECTOR

WINKELVERSCHRAUBUNG

RACCORD EQUERRE

RACOR A L INTERMEDIO

CONEXÃO EM "L" TUBO-TUBO

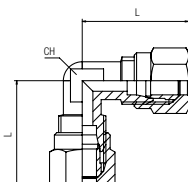

Code	Tube	L	CH	Pack.
09260 00 001	4	21	8	10
09260 00 002	6	22.5	9	10
09260 00 003	8	26.5	12	10
09260 00 004	10	31.5	13	10
09260 00 005	12	34.5	14	10
09260 00 006	14	38	17	10
09260 00 007	15	37.5	17	10
09260 00 008	16	44	19	10
09260 00 009	18	44	22	10

9280

RACCORDO A L MASCHIO

ELBOW MALE ADAPTOR
WINKELVERSCHRAUBUNG KONISCH
EQUERRE MÂLE CONIQUE
RACOR A L MACHO
CONEXÃO EM "L" COM ROSCA MACHO

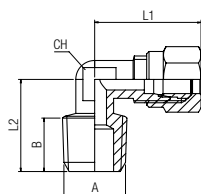

Code	Tube	A	B	L1	L2	CH	Pack.
09280 00 001	4	1/8	7.5	22	15	8	10
09280 00 002	6	1/8	7.5	23.5	17	9	10
09280 00 003	6	1/4	11	24	19.5	9	10
09280 00 004	8	1/8	7.5	26.5	18	12	10
09280 00 005	8	1/4	11	26.5	21.5	11	10
09280 00 006	8	3/8	11.5	29.5	24.5	13	10
09280 00 007	10	1/4	11	33	23.5	13	10
09280 00 008	10	3/8	11.5	33	24.5	13	10
09280 00 009	12	3/8	11.5	34.5	25	14	10
09280 00 010	12	1/2	14	34.5	28	15	10
09280 00 011	14	1/2	14	38.5	30	17	10
09280 00 012	15	1/2	14	37	29	17	10
09280 00 013	16	1/2	14	43	31.5	19	10
09280 00 014	18	1/2	14	44	33.5	22	10

9460

RACCORDO DIRITTO INTERMEDIO

STRAIGHT CONNECTOR
VERBINDUNGSVERSCHRAUBUNG
RACCORD UNION DOUBLE
RACOR RECTO INTERMEDIO
CONEXÃO RETA TUBO-TUBO

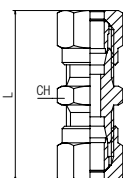

Code	Tube	L	CH	Pack.
09460 00 001	4	36	9	10
09460 00 002	6	39	12	10
09460 00 003	8	39	12	10
09460 00 004	10	48	17	10
09460 00 005	12	49	19	10
09460 00 006	14	53	24	10
09460 00 007	15	50	24	10
09460 00 008	16	53.5	27	10
09460 00 009	18	53	27	10

9480

RACCORDO DIRITTO MASCHIO

STRAIGHT MALE ADAPTOR
GERADE EINSCHRAUBVERSCHRAUBUNG KONISCH
RACCORD DROIT MÂLE CONIQUE
RACOR RECTO MACHO
CONEXÃO RETA COM ROSCA MACHO

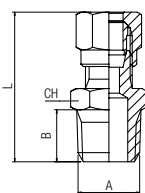

Code	Tube	A	B	L	CH	Pack.
09480 00 001	4	1/8	7.5	27.5	11	10
09480 00 002	6	1/8	7.5	28	11	10
09480 00 003	6	1/4	11	31.5	14	10
09480 00 004	8	1/8	7.5	30	12	10
09480 00 005	8	1/4	11	33.5	14	10
09480 00 006	8	3/8	11.5	35	17	10
09480 00 007	10	1/4	11	38	16	10
09480 00 008	10	3/8	11.5	38.5	17	10
09480 00 009	12	3/8	11.5	38.5	18	10
09480 00 010	12	1/2	14	41.5	21	10
09480 00 011	14	1/2	14	44	22	10
09480 00 012	15	1/2	14	43.5	22	10
09480 00 013	16	1/2	14	45	24	10
09480 00 014	18	1/2	14	45	26	10

9500

RACCORDO DIRITTO FEMMINA

STRAIGHT FEMALE ADAPTOR
AUFSCHRAUBVERSCHRAUBUNG
RACCORD DROIT TARAUDEE
RACOR RECTO HEMBRA
CONEXÃO RETA COM ROSCA FÊMEA

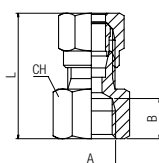

Code	Tube	A	B	L	CH	Pack.
09500 00 001	4	1/8	8.5	26.5	14	10
09500 00 002	6	1/8	8.5	26.5	14	10
09500 00 003	6	1/4	11	30	17	10
09500 00 004	8	1/8	8.5	27.5	14	10
09500 00 005	8	1/4	11	31	17	10
09500 00 006	8	3/8	11.5	32.5	20	10
09500 00 007	10	1/4	11	32.5	17	10
09500 00 008	10	3/8	11.5	34.5	20	10
09500 00 009	12	3/8	11.5	34.5	20	10
09500 00 010	12	1/2	15	39	24	10
09500 00 011	14	1/2	15	40	24	10
09500 00 012	15	1/2	15	39.5	24	10
09500 00 013	16	1/2	15	41	24	10
09500 00 014	18	1/2	15	41	26	10

9550

RACCORDO ORIENTABILE A L CON VITE

SINGLE BANJO BODY WITH STEM
WINKELSCHWENKVERSCHRAUBUNG (DREHBAR)
EQUERRE MÂLE BANJO, ORIENTABLE
RACOR ORIENTABLE A L CON TORNILLO
CONEXÃO EM "L" ORIENTÁVEL TIPO BANJO

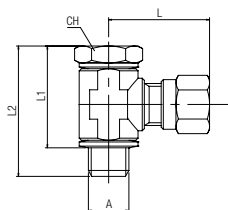

Code	Tube	A	L	L2	L1	CH	Pack.
09550 00 001	4	1/8	23	31	24	14	10
09550 00 002	6	1/8	24	31	24	14	10
09550 00 003	6	1/4	27.5	32	24.5	17	10
09550 00 004	8	1/8	27.5	31	24	14	10
09550 00 005	8	1/4	27.5	32	24.5	17	10
09550 00 006	8	3/8	30	37.5	24.5	19	10
09550 00 007	10	1/4	33	32	24.5	17	10
09550 00 008	10	3/8	33.5	36	27.5	19	10
09550 00 009	12	3/8	36	46	38	22	10

	min	max
Temperature	- 20 °C	+ 80 °C

9680

DADO

NUT
ÜBERWURFMUTTER
ECROU
TUERCA
PORCA

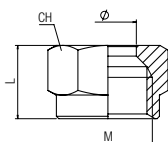

Code	Tube	L	CH	M	Pack.
09680 00 01 X1 NB	4 LL	11	10	M8x1	50
09680 00 01 X4 NB	6 LL	11.5	12	M10x1	50
09680 00 01 X7 NB	8 LL	12	14	M12x1	50
09680 00 01 X9 NB	10 L	15.5	19	M16x1.5	50
09680 00 01 Y1 NB	12 L	15.5	22	M18x1.5	50
09680 00 01 Y3 NB	14 S	18.5	27	M22x1.5	20
09680 00 01 Y4 NB	15 L	17	27	M22x1.5	20
09680 00 01 Y5 NB	16 S	18.5	30	M24x1.5	20
09680 00 01 Y7 NB	18 L	18	32	M26x1.5	20

9740

OGIVA

OLIVE
KLEMMRING
BAGUE BICÔNE
BICONO
BUCHA

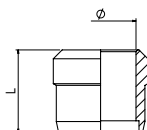

Code	Tube	L	Pack.
09740 00 02 X1 00	4 LL	6	50
09740 00 02 X4 00	6 LL	7	50
09740 00 02 X7 00	8 LL	7.5	50
09740 00 02 X9 00	10 L	9.5	50
09740 00 02 Y1 00	12 L	9.5	50
09740 00 02 Y3 00	14 S	9.5	20
09740 00 02 Y4 00	15 L	9.5	20
09740 00 02 Y5 00	16 S	9.5	20
09740 00 02 Y7 00	18 L	10	20

10770

BUSSOLA DI RINFORZO

INTERNAL SUPPORT BUSH
STÜTZHÜLSE MESSING
FOURRURE INTÉRIEURE
REFUERZO
BUCHA DE REFORÇO INTERNA

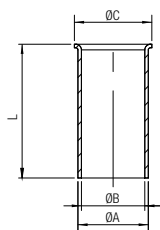

Code	Tube	A	B	C	L	Pack.
10770 00 01 1D 00	4/2.7	2.7	2.1	3.7	13	10
10770 00 01 3D 00	6/4	4	3.2	5	13	10
10770 00 01 4D 00	8/6	6	5	7	16.5	10
10770 00 01 5D 00	10/8	8	7	9	17	10
10770 00 01 7D 00	12/9	9	8	11	19	10
10770 00 01 8D 00	12/10	10	9	11	19	10
10770 00 01 0E 00	14/12	12	11	13.5	21	10
10770 00 01 1E 00	15/12.5	12.5	11.6	14	21	10
10770 00 01 3E 00	16/13	13	12	15.5	22	10
10770 00 01 7E 00	18/15	15	14	17.5	23	10
10770 00 01 8E 00	18/16	16	15	17.5	23	10
10770 00 01 0F 00	22/18	18	17	21	25	10